









Ficha técnica

Rueda B-PGI 1-0017

| Codigo |  |  |  | Tipo cojinete Eje |  |  |  |  |  |
|--------|---|---|---|----------------------|---|--|---|---|---|
| 1-0017 | 60 | 25 | 18 | — | - | - | 10 | 78 | 53 |



Características

Fabricada con chapa de acero embutida hasta 2 mm de espesor.
Soporte con rodamiento a bolas.
Acabado cincado.
Ruedas de goma de 50 y 60 de diámetro con protectores incluidos de serie.
Fabricadas según normas europeas EN 12528.

Datos técnicos

Diámetro: 60 mm
Carga: 25 kg
Tipo de cojinete: Cojinete Liso
Ancho de Banda de rodadura: 18 mm
Diámetro agujero pasante: 10 mm
Altura total: 78 mm
Radio de giro: 53 mm

Archivos CAD

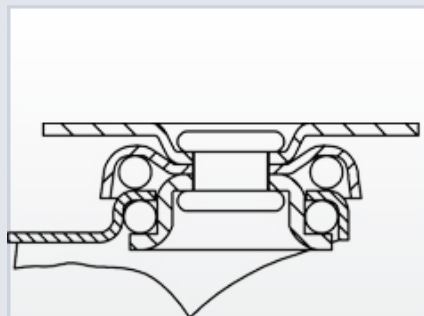

Rueda

PGI (Goma)
Núcleo de poliamix y banda de goma gris
Rango de temperatura: -20° ÷ +60°

Productos relacionados

