

# SIMONWORK BT5 BOX 900



**84,2 x 91 x 61 cm**  
**33.1" x 35.8" x 24.0"**



**5** Años Garantía  
 Years Guarantee  
 Jahre Garantie  
 Ans Garantie  
**SIMONRACK**

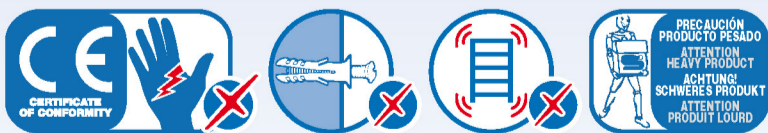
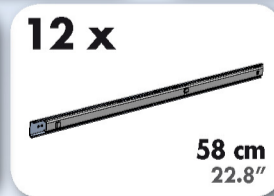
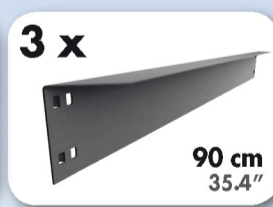
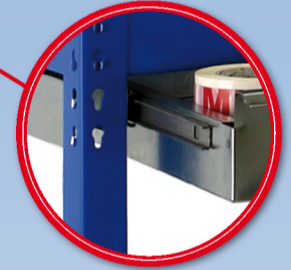
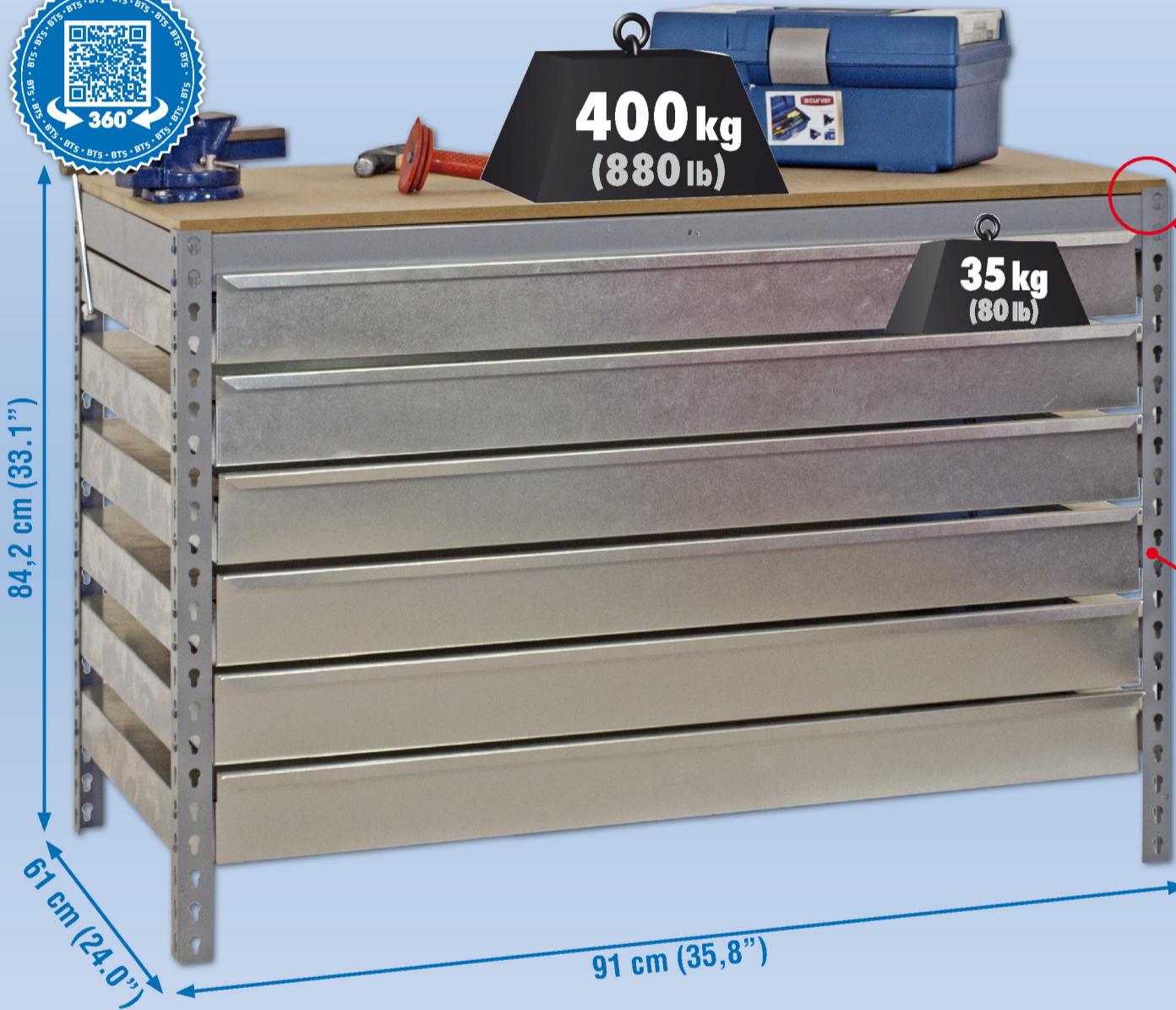

ESTANTERIAS SIMON S.L. B.50.556.463  
 PG. ALFAMEN C/ POLIGONO C. Nº3  
 ALFAMEN (ZARAGOZA)



[www.simonrack.com](http://www.simonrack.com)



INSTRUCCIONES  
 INSTRUCTIONS  
 ANLEITUNG  
 INSTRUCTIONS

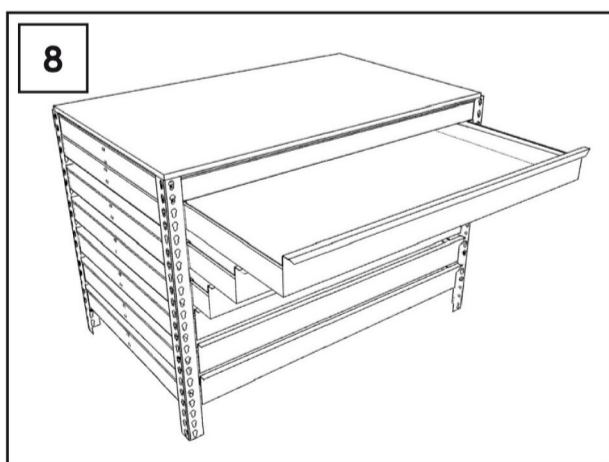
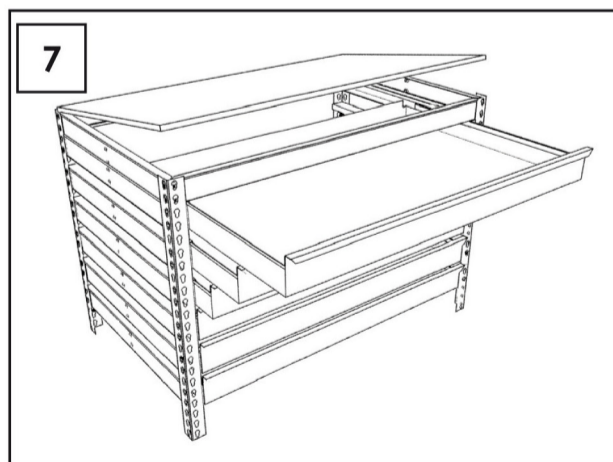
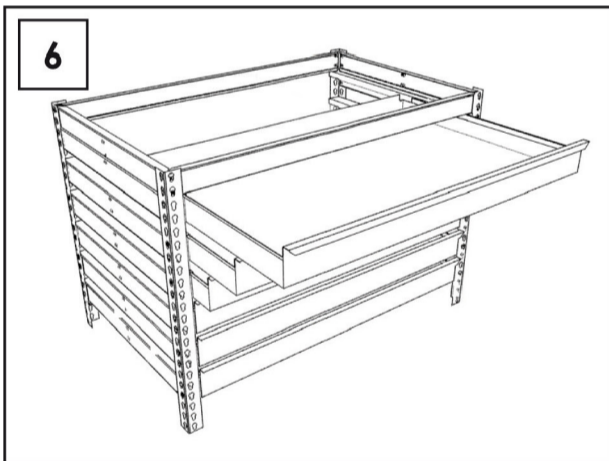
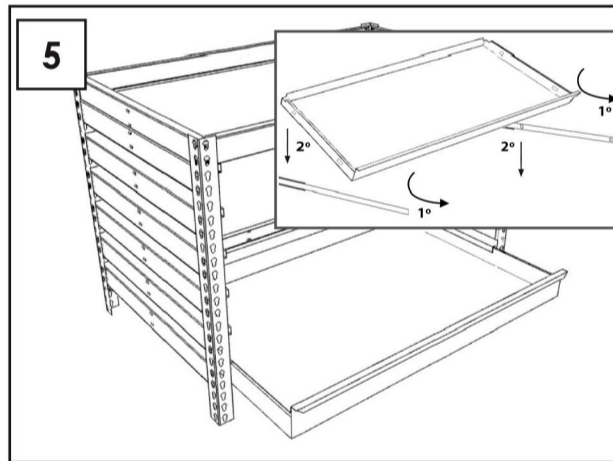
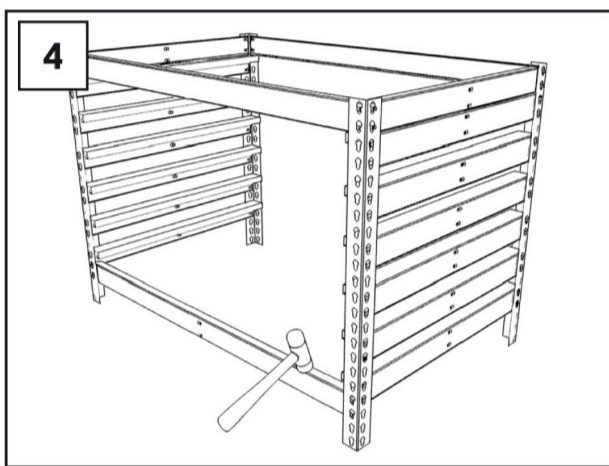
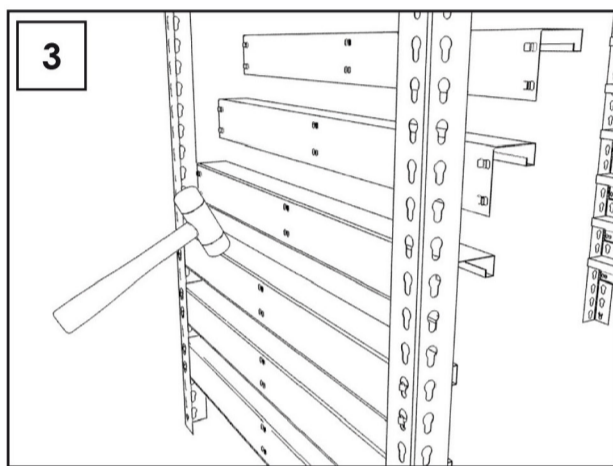
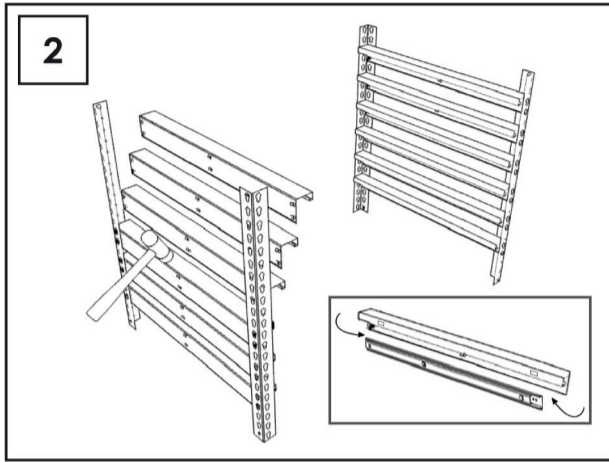
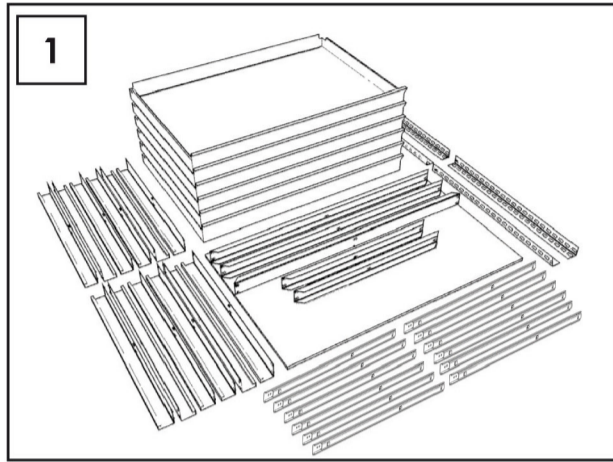

**SIMONCLASSIC**



**SIMONCLICK**



**SIMONTALLER**



**SIMONAUTO**



**SIMONWORK**



**SIMONLOCKER**

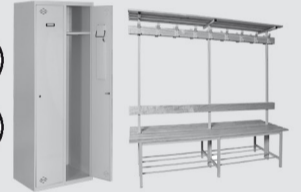

**SIMONOFFICE**

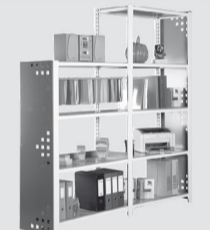

**SIMONHOME**

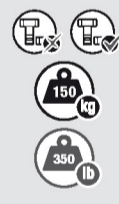

**SIMONGARDEN**



**SIMONTITÁN**



**SIMONINOX**

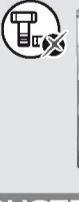

**SIMONINDUSTRIAL**

**SIMONPALET**



**SIMONLEVER**



ALTILLOS Y PASILLOS ELEVADOS  
PLATFORMS AND MEZZANINES  
LAGERBÜHNEN • PLATES-FORMES ET MEZZANINES

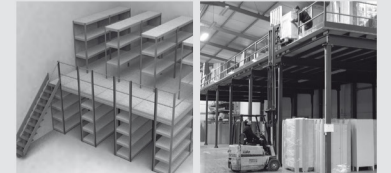

\* Kg / lb por bandeja con carga uniformemente repartida  
Kg / lb per shelf uniformly distributed load  
Kg / lb pro fach bei gleichmäßig verteilter Last  
Kg / lb par plateau avec charge uniformément répartie