

SIMONWORK BTO BOX 900



84,2 x 91 x 61 cm
33.1" x 35.8" x 24.0"



5 Años Garantía
 Years Guarantee
 Jahre Garantie
 Ans Garantie
SIMONRACK

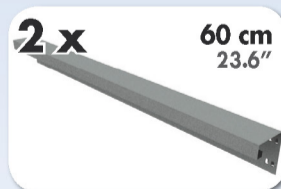
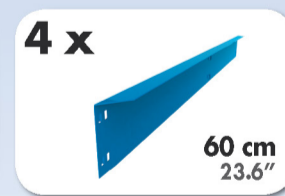
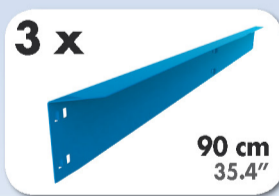
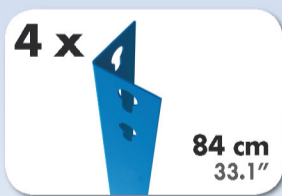

ESTANTERIAS SIMON S.L. B.50.556.463
 PG. ALFAMEN C/ POLIGONO C. Nº3
 ALFAMEN (ZARAGOZA)



www.simonrack.com



Management System
 ISO 9001:2008
www.tuv.com
 ID 910504425

INSTRUCCIONES
 INSTRUCTIONS
 ANLEITUNG
 INSTRUCTIONS

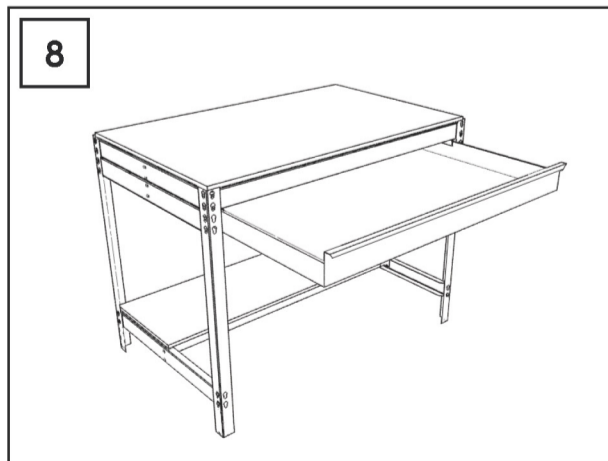
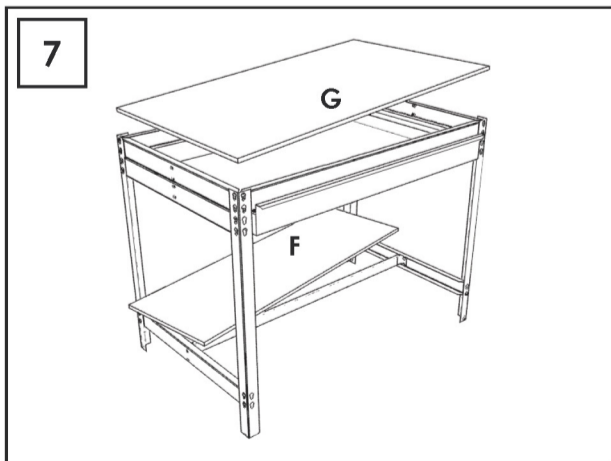
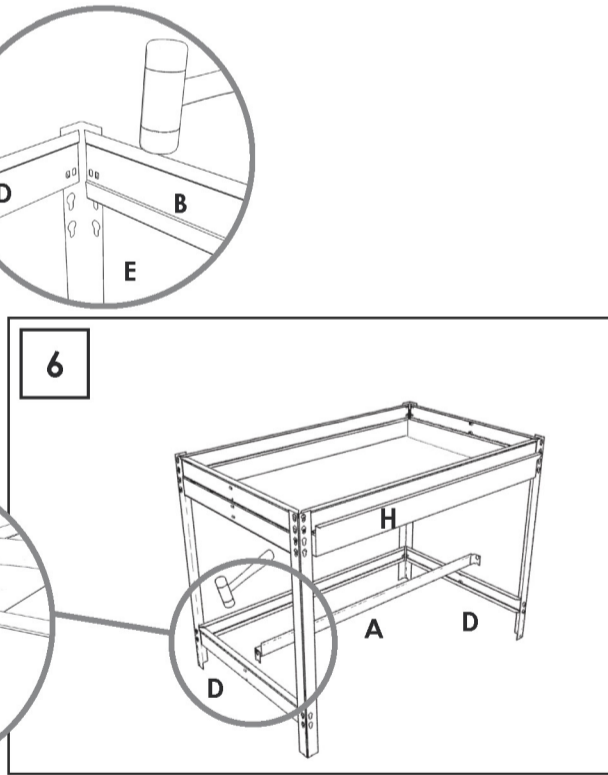
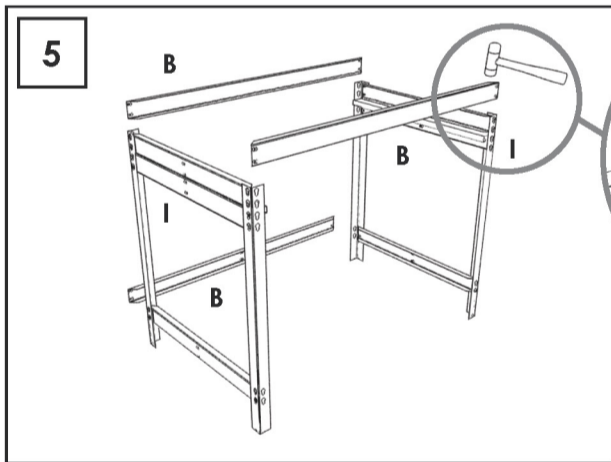
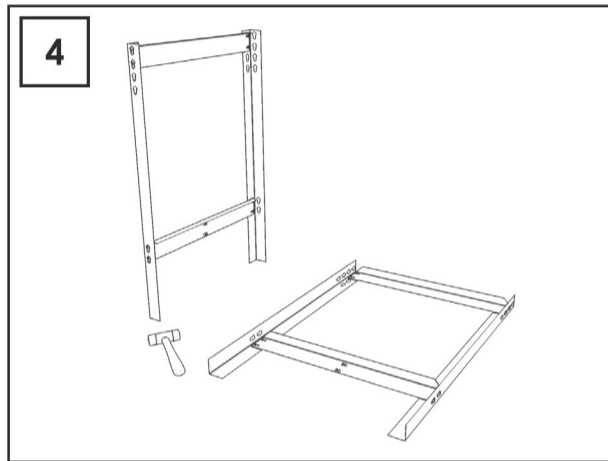
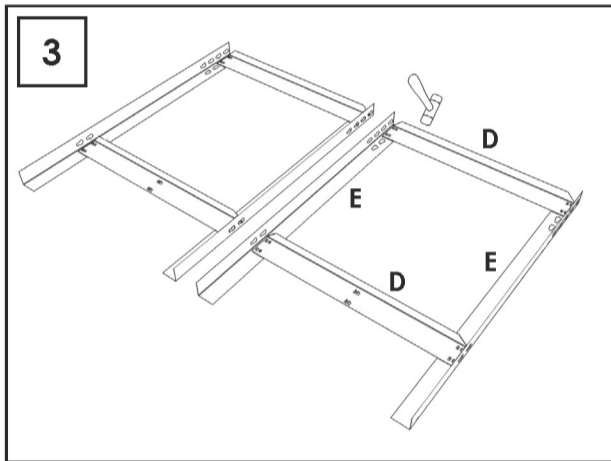
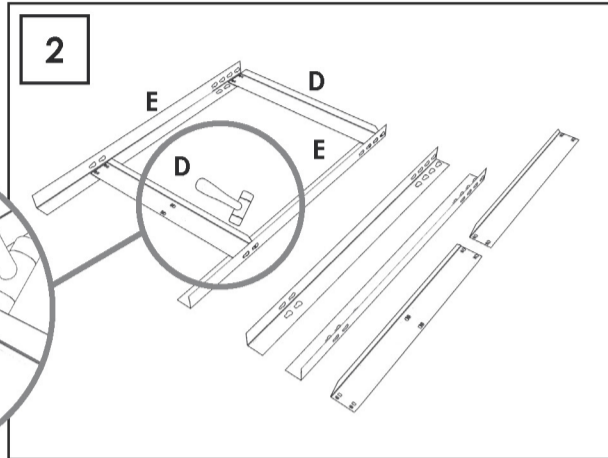
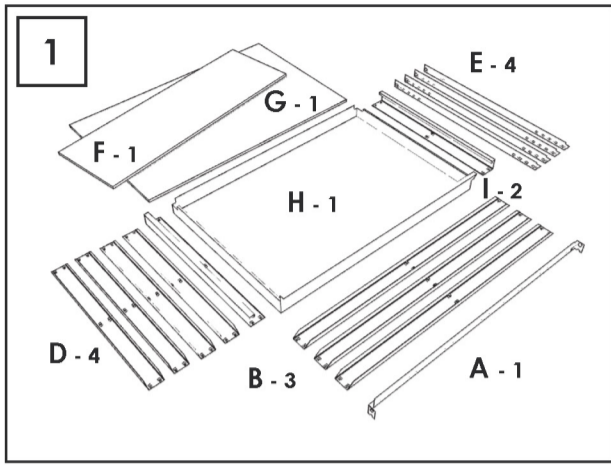

SIMONCLASSIC



SIMONCLICK



SIMONTALLER



SIMONAUTO

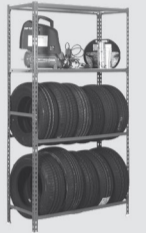

SIMONWORK



SIMONLOCKER

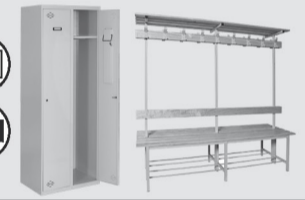

SIMONOFFICE



SIMONHOME

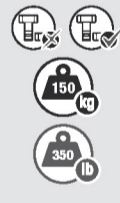

SIMONGARDEN



SIMONTITÁN



SIMONINOX



SIMONINDUSTRIAL



ALTILLOS Y PASILLOS ELEVADOS
PLATFORMS AND MEZZANINES
LAGERBÜHNEN • PLATES-FORMES ET MEZZANINES



* Kg / lb per bandeja con carga uniformemente repartida
Kg / lb per shelf uniformly distributed load
Kg / lb pro fach bei gleichmäßig verteilter last
Kg / lb par plateau avec charge uniformément répartie

